

# Events Safety



# About Us



**Tiantai Yongsheng Traffic facilities Co.,ltd.** is a factory dedicated to the production of rubber material facilities products and the development of products using exclusive rubber production technologies. We are a domestic production base for the large-scale production of rubber transportation facilities, integrating production, processing, and customization. The company also integrates chemical products and relies on high-quality rubber materials to establish a foothold in the rubber traffic facilities market.

With over 2,000 tons of rubber traffic facilities annually, our products are mainly exported to the United States, Australia, Canada, United Kingdom, Spain, Italy, the Netherlands, South Korea, Russia, Germany, etc. Many of our cooperative customers in dozens of countries sell rubber traffic facilities and rubber ramps and have become important suppliers of their traffic facilities in China.

We are a company committed to building long-term partnerships with our customers all around the world. Our goal is to be your primary source for all kinds of traffic safety and parking lot products. Our tenets are integrity, Innovation, Diligence and Humanity.



# Contents

- 01 1-Channel Small Cable Cover
- 02 Drop Over Cable Cover
- 03 1-Channel Big Cable Cover
- 04 Hose Bridge
- 05 Rubber Cable Cover
- 06 2-Channel Cable Cover
- 07 3-Channel Cable Cover
- 08 4-Channel Cable Cover
- 09 5-Channel Cable Cover
- 10 ADA Cable Cover
- 11 Fold Cable Cover
- 12 Blue Rubber+Plastic Cable Cover
- 13 Rubber+Plastic Cable Cover
- 14 Easy Spin Retractable Stanchion
- 15 Wall Mount Bracker+Receiver Clipe

**Tiantai Yongsheng Traffic facilities Co.,ltd**, established in 2011 , is a professional engaged in the research, development, sale and service of Speed bump, cable protector , curb ramp .

Selling well in all cities and provinces around China, our products are also exported to clients in such countries and regions as America , Europe and Australia. We also welcome OEM and ODM orders. Whether selecting a current product from our catalog or seeking engineering assistance for your application, you can talk to our customer service center about your sourcing requirements.

# 1-Channel Small Cable Cover



1xc02-bend



1xc02

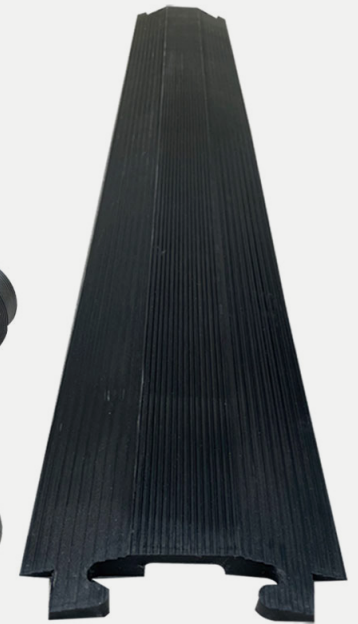

1xc06

- INDOOR/OUTDOOR USE
- Protect cables from foot traffic and vehicles at golf, charity and sporting events.
- Industrial all-weather polyurethane resists oil and abrasions.
- Textured surface. Interlocking connectors.
- Full top and bottom protection. Hinged lid.



View Video

Model	Length	Width	Height	Weight	Material	Channel	Channel size
1XC02	1000mm	150mm	30mm	3kg	Rubber	1	20*20mm
1XC06	1000mm	135mm	20mm	2kg	Rubber	1	35*15mm
1XC07	1000mm	220mm	35mm	3.5kg	Rubber	1	85*25mm

# Drop Over Cable Cover



**Big Cable Cover**

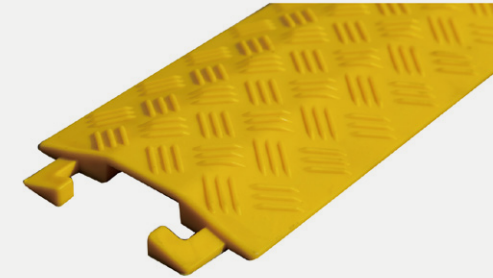

L-Shaped Connection is convenient and firm

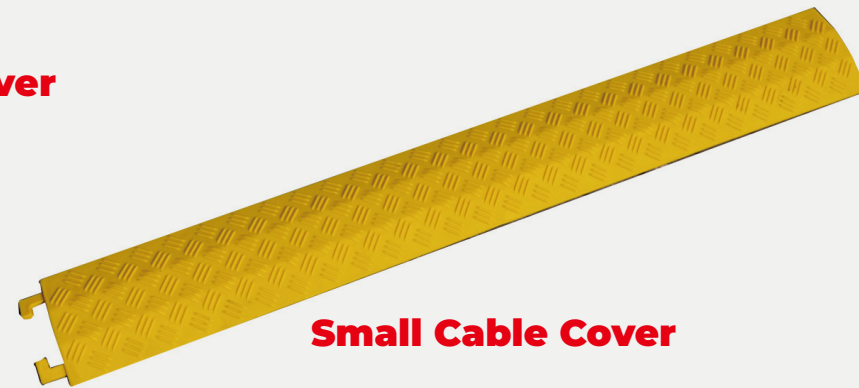

**Small Cable Cover**

- Drop Over Cable cover are a quick and easy solution of cable management. The durable polyurethane is ideal for constant pedestrian foot traffic. A low profile cover provide maximum traction to help reduce the hazards of tripping or slipping. These drop over cable covers are a fast and effective way of protecting small cables and cords in your home, office, or warehouse.

Model	Length	Width	Height	Weight	Material	Channel	Channel size
1XC04	1000mm	120mm	25mm	1kg	PVC	1	40*15mm
1XC05	1000mm	280mm	40mm	2.4kg	PVC	1	100*30mm
2XC10	1000mm	280mm	40mm	2.2kg	PVC	2	50*30mm



# 1-Channel Big Cable Cover

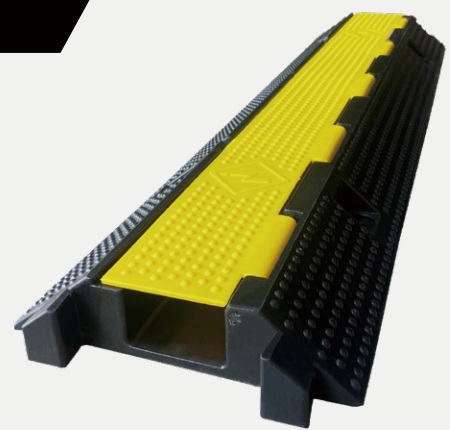

1xc09



1xc10

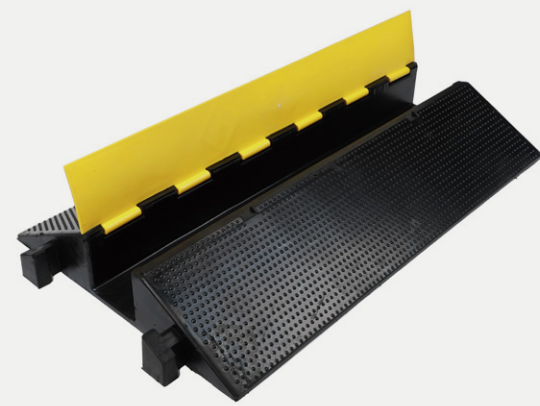

1xc11

- Using to bicycle, wheelchair's and Car ramp(Roadway<-->Sidewalk).
- Easy to install move and sustain performance of strength force up to 20 ton.
- Available to keep the vehicle inside and using to install for emergency situation.
- High performance of face grip and high brightness reflective sheet on the product.



View 1xc09 Video

Model	Length	Width	Height	Weight	Material	Channel	Channel size
1XC09	1000mm	220mm	30mm	5.0kg	Rubber&PVC	1	70*20mm
1XC10	1000mm	250mm	60mm	7.2kg	Rubber&PVC	1	70*47mm
1XC11	1000mm	600mm	125mm	20.5kg	Rubber&PVC	1	110*105mm

# Hose Bridge



2xc11

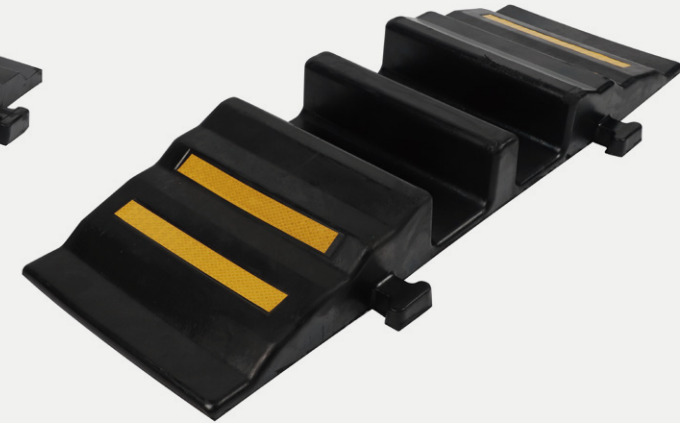

2xc12

- The 2-Channel Hose Bridge uses up to 10cm diameter, protecting them from heavy vehicle traffic. Hose bridges are a high traffic areas by protecting master streamlines from bulges caused when heavy vehicles run over the lines.
- Using to bicycle, wheelchair's and Car ramp(Roadway<-->Sidewalk).
- Easy to install move and sustain performance of strength force up to 20 ton.
- Available to keep the vehicle inside and using to install for emergency situation.
- High performance of face grip and high brightness reflective sheet on the product.



Model	Length	Width	Height	Weight	Material	Channel	Channel size
2XC11	850mm	300mm	125mm	16.8kg	Rubber	2	100*95mm
2XC12	860mm	300mm	60mm	14.5kg	Rubber	2	100*70mm

# Rubber Cable Cover



2xc01

2xc02

- INDOOR/OUTDOOR USE
- Protect cables from foot traffic and vehicles at golf, charity and sporting events.
- Industrial all-weather polyurethane resists oil and abrasions.
- Textured surface. Interlocking connectors.
- Full top and bottom protection. Hinged lid.

Model	Length	Width	Height	Weight	Material	Channel	Channel size
2XC01	1000mm	150mm	30mm	3.2kg	Rubber	2	20*20mm
2XC02	1000mm	220mm	45mm	2kg	Rubber	2	30*30mm



## 2-Channel Cable Cover



2xc05



2xc07

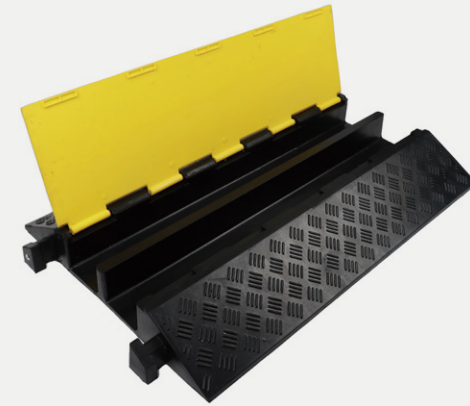

2xc09

- These heavy duty Rubber cable protectors have multiple channels for protection of many wires. Hinged lid is good for top loading of cables and convenience. Made of durable recycle rubber it is suitable for outdoors and indoors in diverse weather conditions. The black body with a yellow lid is highly visible. These units will protect your cables from vehicles up to 15,000 pounds per axle.

Model	Length	Width	Height	Weight	Material	Channel	Channel size
2XC04	1000mm	250mm	50mm	6kg	Rubber&PVC	2	34*34mm
2XC05	1000mm	250mm	50mm	6kg	Rubber&PVC	2	32*32mm
2XC07	1000mm	250mm	50mm	7.6kg	Rubber&PVC	2	32*32mm
2XC08	1000mm	350mm	70mm	9.8kg	Rubber&PVC	2	50*50mm
2XC09	900mm	600mm	90mm	18.6kg	Rubber&PVC	2	95*75mm

# 3-Channel Cable Cover

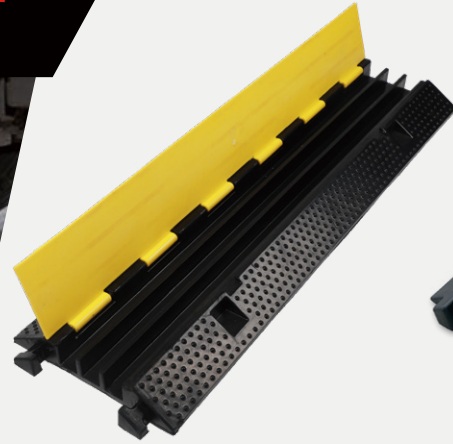

3xc02

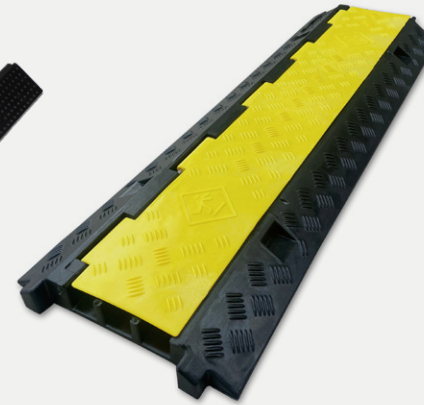

3xc05

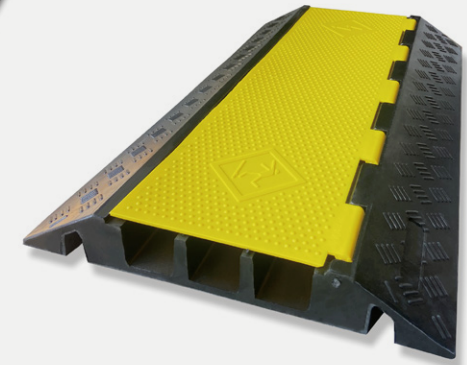

3xc03

- These heavy duty Rubber cable protectors have multiple channels for protection of many wires. Hinged lid is good for top loading of cables and convenience. Made of durable recycle rubber it is suitable for outdoors and indoors in diverse weather conditions. The black body with a yellow lid is highly visible. These units will protect your cables from vehicles up to 15,000 pounds per axle.

Model	Length	Width	Height	Weight	Material	Channel	Channel size
3XC01	1000mm	300mm	50mm	8.5kg	Rubber&PVC	3	30*30mm
3XC02	1000mm	300mm	50mm	9kg	Rubber&PVC	3	32*32mm
3XC03	900mm	500mm	70mm	15kg	Rubber&PVC	3	65*55mm
3XC04	900mm	500mm	85mm	17kg	Rubber&PVC	3	75*65mm
3XC05	1000mm	300mm	50mm	8.5kg	Rubber&PVC	3	35*30mm



# 4-Channel Cable Cover

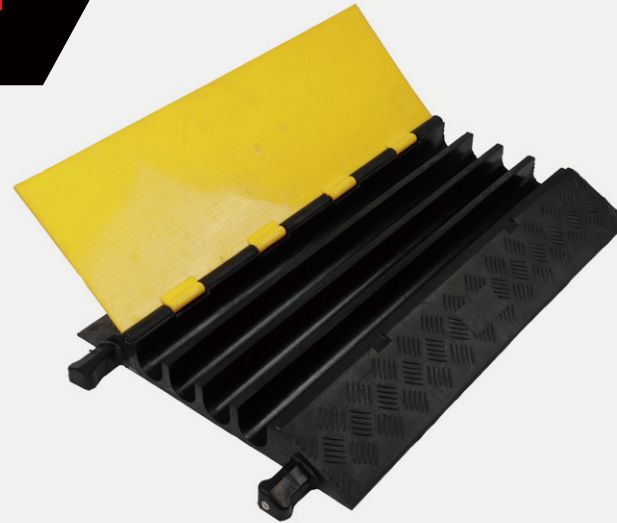

4xc01

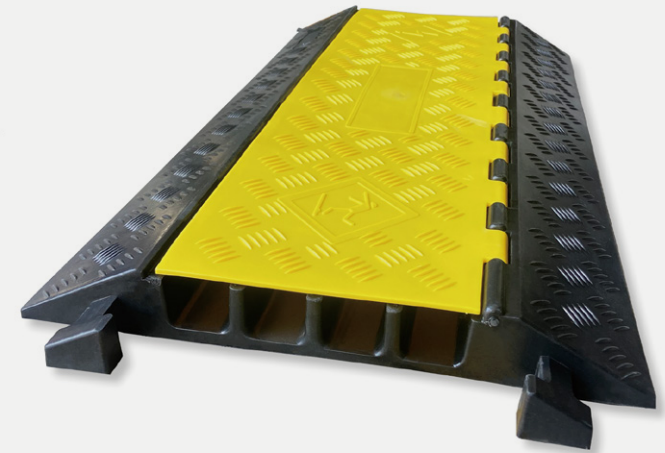

4xc03

- These heavy duty Rubber cable protectors have multiple channels for protection of many wires. Hinged lid is good for top loading of cables and convenience. Made of durable recycle rubber it is suitable for outdoors and indoors in diverse weather conditions. The black body with a yellow lid is highly visible. These units will protect your cables from vehicles up to 15,000 pounds per axle.



Bend

Model	Length	Width	Height	Weight	Material	Channel	Channel size
4XC01	900mm	500mm	70mm	13.7kg	Rubber&PVC	4	50*50mm
Bend	200mm	500mm	70mm	3.6kg	Rubber&PVC	4	50*50mm
4XC03	900mm	500mm	70mm	15kg	Rubber&PVC	4	50*50mm

# 5-Channel Cable Cover

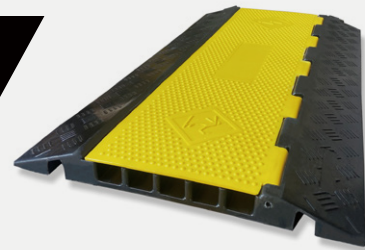

5xc02

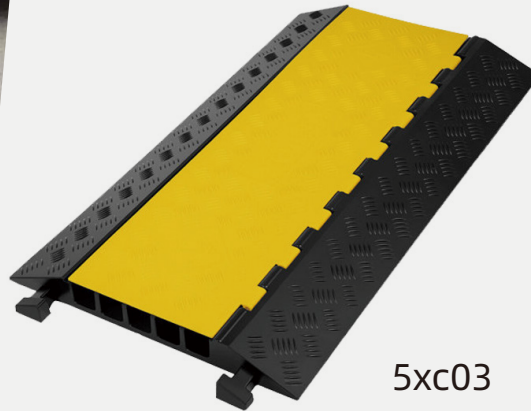

5xc03



5xc02-bend

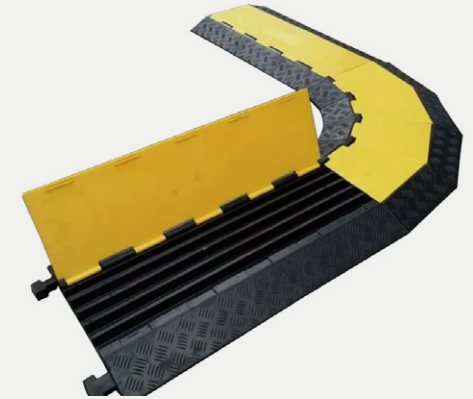

- These heavy duty Rubber cable protectors have multiple channels for protection of many wires. Hinged lid is good for top loading of cables and convenience. Made of durable recycle rubber it is suitable for outdoors and indoors in diverse weather conditions. The black body with a yellow lid is highly visible. These units will protect your cables from vehicles up to 15,000 pounds per axle.

Model	Length	Width	Height	Weight	Material	Channel	Channel size
5XC02	900mm	500mm	50mm	11.5kg	Rubber&PVC	5	35*35mm
Bend	300mm	500mm	50mm	3.2kg	Rubber&PVC	5	35*35mm
5XC03	900mm	500mm	50mm	12.kg	Rubber&PVC	5	35*35mm



# ADA Cable Cover

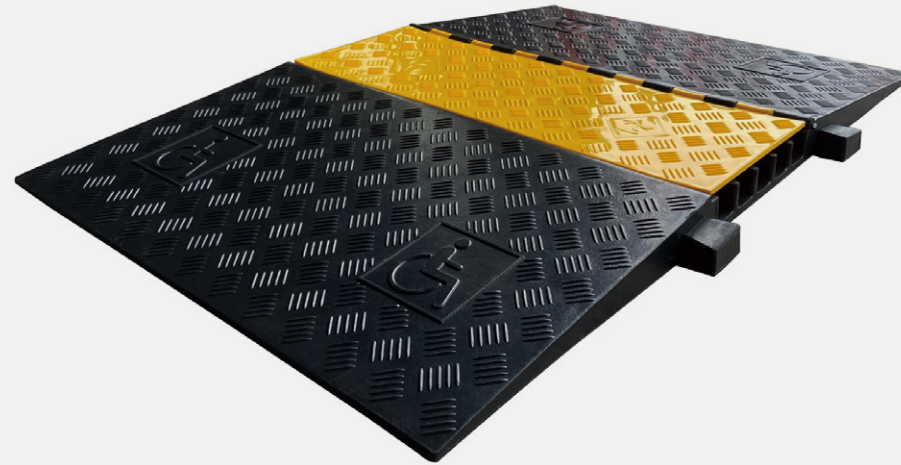
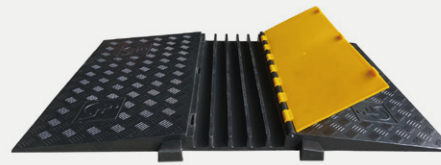
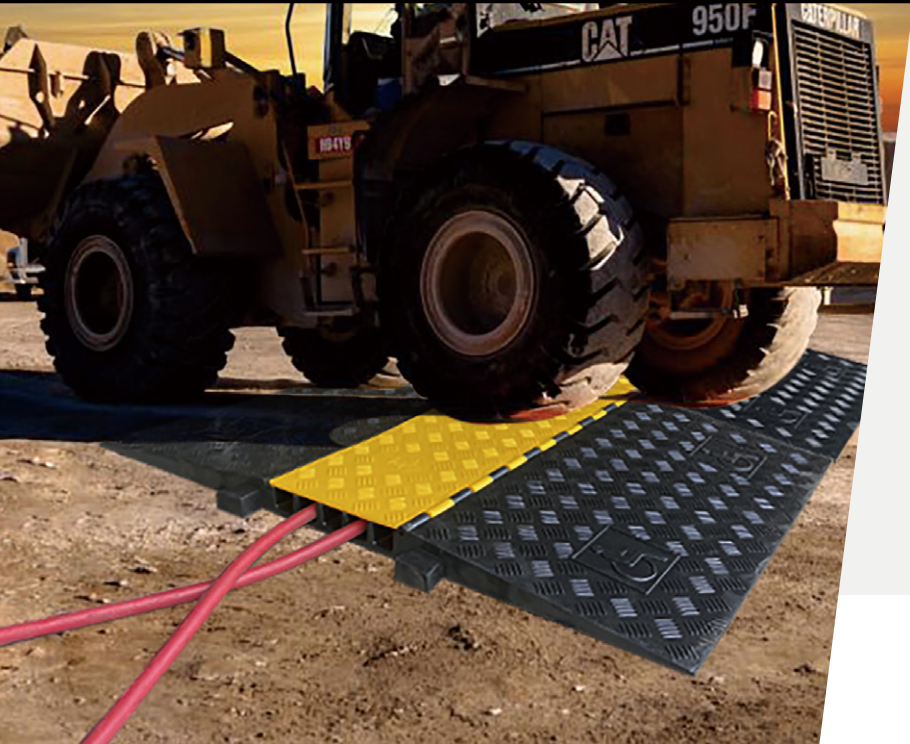

YS-LY5XC-1

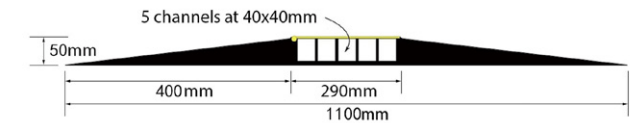

Model	Length	Width	Height	Weight	Material	Channel	Channel size
YS-LY5XC-1	1100mm	750mm	50mm	20.5kg	Rubber&PVC	5	35*35mm

- The 5-Channel ADA Cable Protector is ADA compliant and features a low profile gentle slope, creating an easy cable crossing point for wheelchair and pedestrian traffic. The ADA Cable Protector is engineered to withstand the abuse of heavy pedestrian and vehicle traffic areas.

5-Channel ADA Cable Protectors feature:

- Heavy-duty, UV-stabilized Polyurethane construction
- High traction tread design
- Radiused divider ends to minimize cable snags
- Easy to use inter-connects

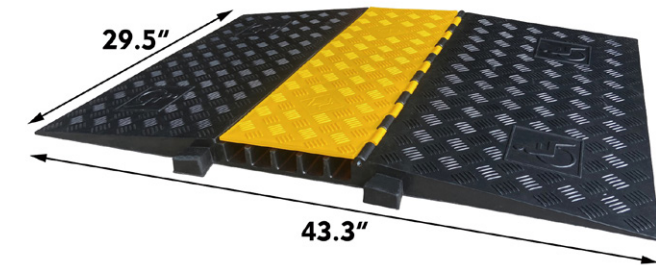

**Net Weight: 19kg/41.8lbs**  
**Capacity: 15000kg/33000lbs**

# Fold Cable Cover

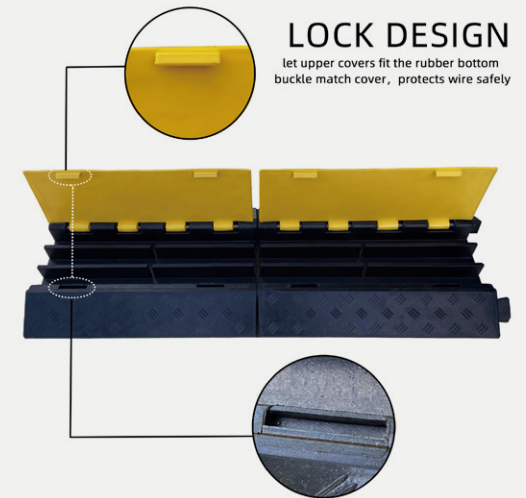
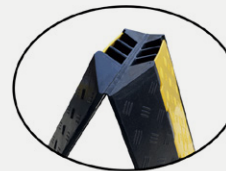
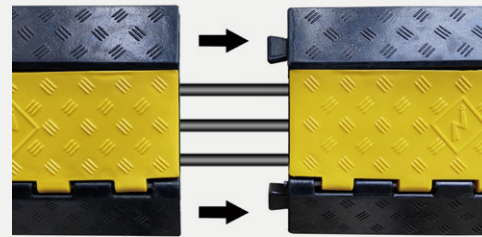

After Fold

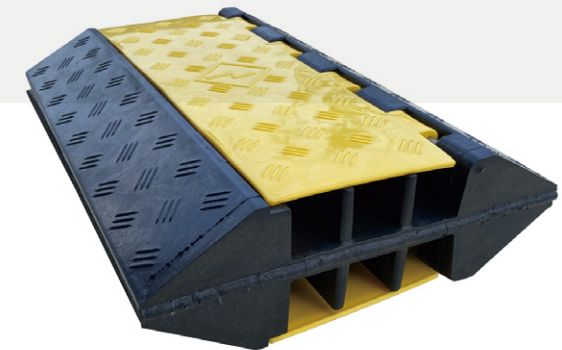

- Modul interlocking
- Excellent load capacity
- Flip-open design
- Vigilant color

ZD3XC06

Model	Length	Width	Height	Weight	Material	Channel	Channel size
ZD3XC06	770mm	280mm	50mm	4.9kg	Rubber&PVC	3	35*35mm

# Blue Rubber+Plastic Cable Cover

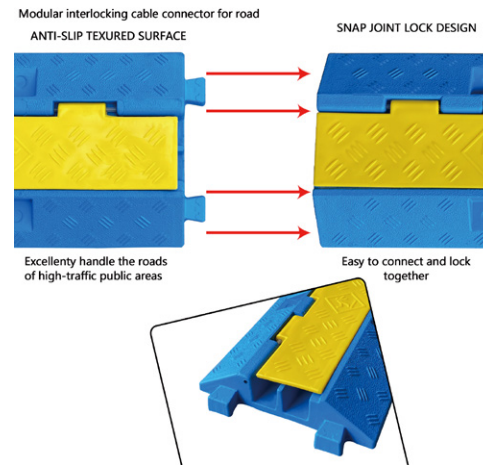
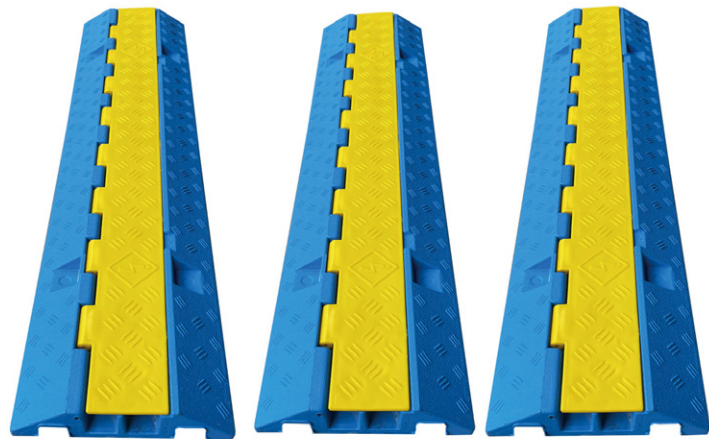
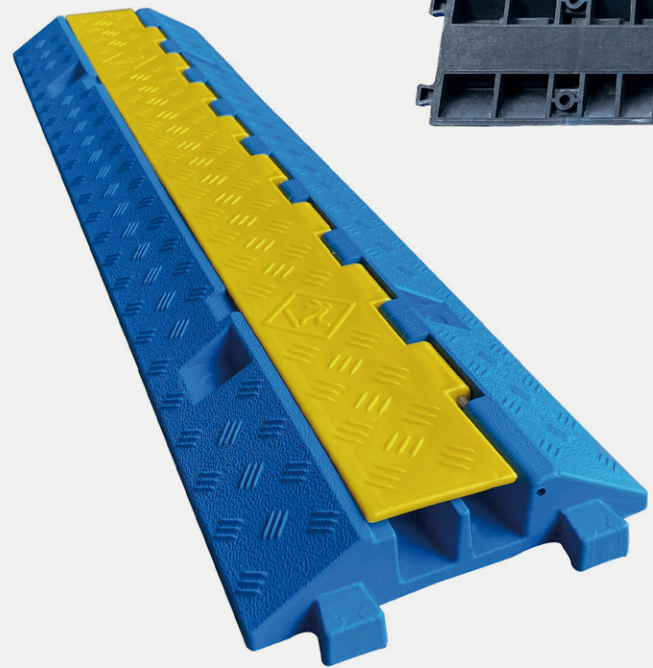

Model	Length	Width	Height	Weight	Material	Channel	Channel size
ZD3XC06	770mm	280mm	50mm	4.9kg	Rubber&PVC	3	35*35mm

# Rubber+Plastic Cable Cover

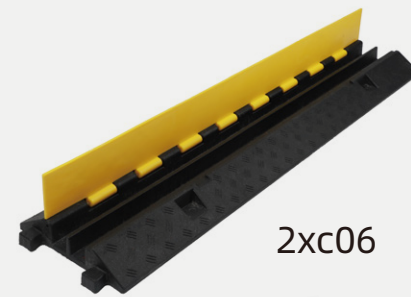

2xc06



3xc07

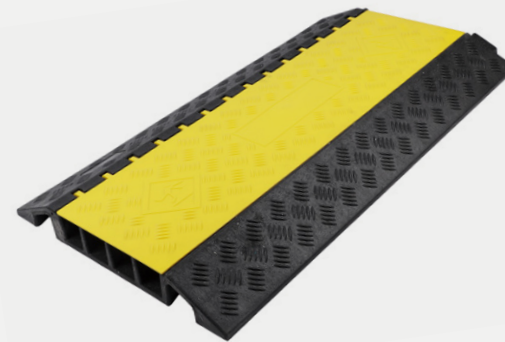

4xc05

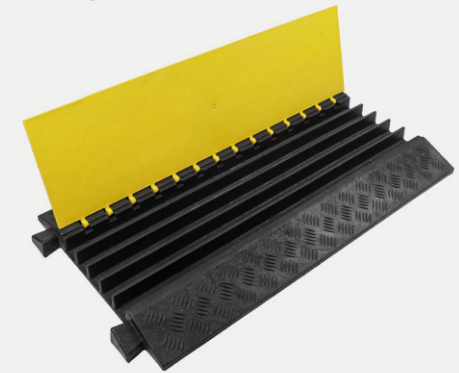

5xc04

- INDOOR/OUTDOOR USE
- Protect cables from foot traffic and vehicles at golf, charity and sporting events.
- Industrial all-weather polyurethane resists oil and abrasions.
- Textured surface. Interlocking connectors.
- Full top and bottom protection. Hinged lid.

Model	Length	Width	Height	Weight	Material	Channel	Channel
1XC03	1000mm	220mm	35mm	4.2kg	Rubber+Plastic&PVC	1	70*18mm
1XC04	1000mm	260mm	60mm	5.8kg	Rubber+Plastic&PVC	1	70*45mm
2XC06	1000mm	250mm	50mm	5.5kg	Rubber+Plastic&PVC	2	32*32mm
2XC13	1000mm	350mm	70mm	8.5kg	Rubber+Plastic&PVC	2	60*55mm
3XC06	1000mm	300mm	50mm	6kg	Rubber+Plastic&PVC	3	35*30mm
3XC07	900mm	500mm	75mm	11.5kg	Rubber+Plastic&PVC	3	70*57mm
4XC05	900mm	500mm	70mm	11kg	Rubber+Plastic&PVC	4	45*45mm
5XC04	900mm	500mm	50mm	10.5kg	Rubber+Plastic&PVC	5	38*38mm



# Easy Spin Retractable Stanchion



YMX01



YMX02

- 1. Different surface color for your choice, like yellow, red, blue and green.
- 2. Many belt colors for your options, logo printed on the belt is available.
- 3. Light weight design post is very easy to handle and carry.
- 4. 2 different bases for your choice, water filled and Rubber base.
- 5. Bottom lock system is much for stable and easy install.
- 6. Anti-slippery designed base.
- 7. Logo can be moulded on the base



View Video



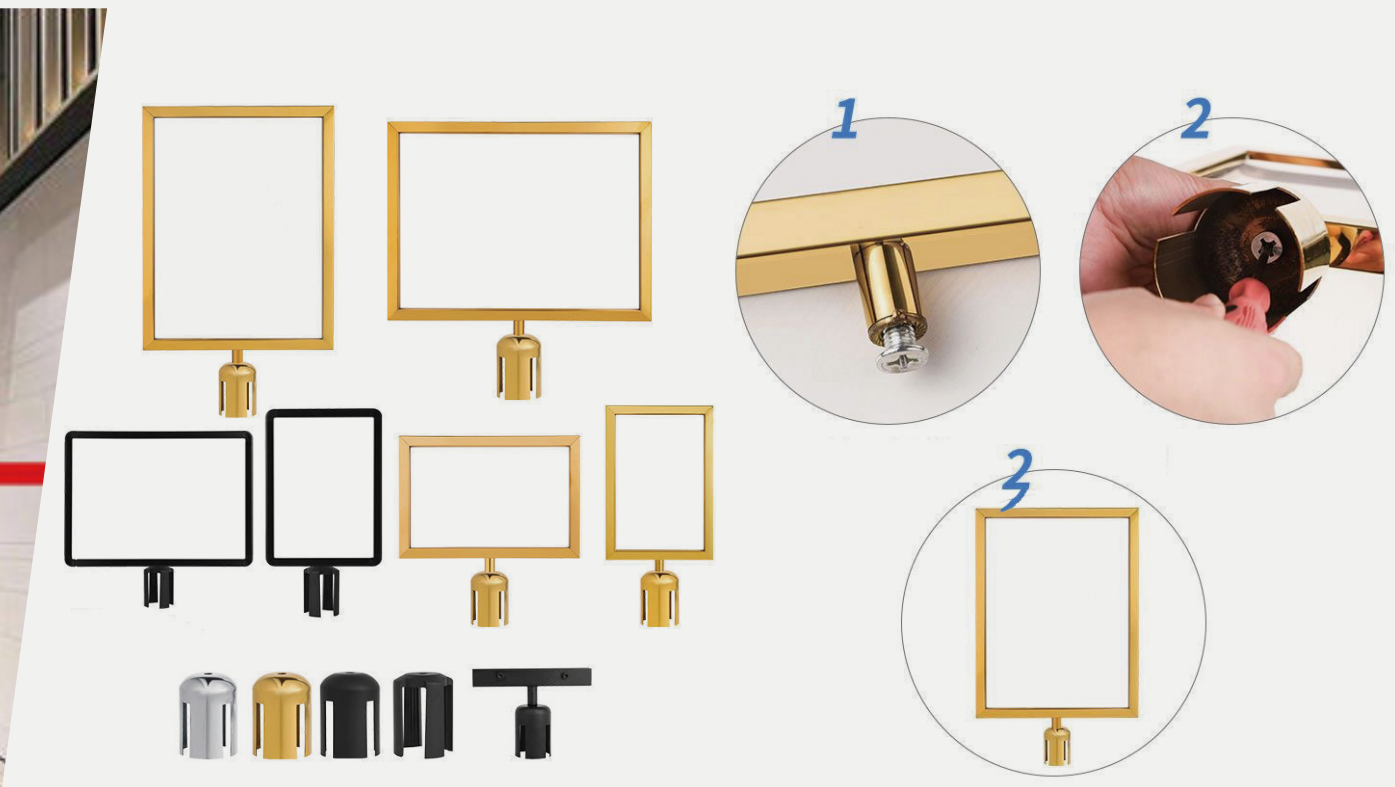

# Wall Mount Bracker+Receiver Clipse

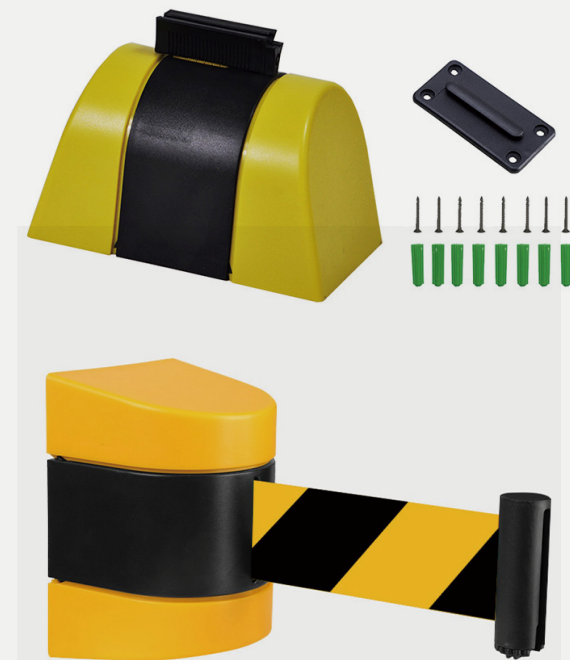
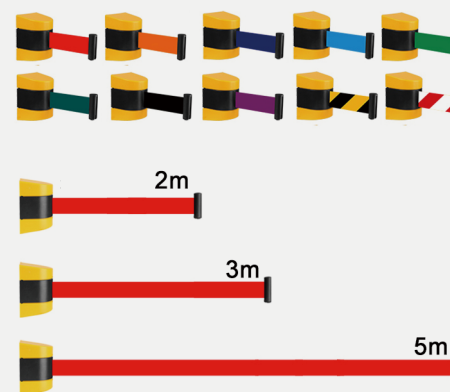

## Product Description

1. These support brackets are available in two versions, Fixing By screw or Adhesie Tape, and allow you to securely hold a Skipper retractable Topper unit in place without the need for a cone or a post.
2. These receiver clips are available in two versions, Fixing By Screw or Adhesive Tape, and allow the retractable tape end to attach directly.
3. The bracket is ideal for attaching to any vehicle or metal shelving while the wall fixing version is intended as a more permanent fixture and simply screws into position.





Tiantai Yongsheng Traffic facilities Co.,ltd.

Add: No. 73, Hongchou West Road, Hongchou Town, Tiantai County,  
Taizhou City, Zhejiang, China

Zip: 317210

E-Mail: [info@ys-traffic.com](mailto:info@ys-traffic.com)

Tel: +86-17338553371

<https://www.ys-traffic.com>

天台县永盛交通设施有限公司

地址：浙江省天台县洪畴镇洪畴西路73号

邮编：317210

电子邮件： [info@ys-traffic.com](mailto:info@ys-traffic.com)

电话：+86-17338553371

网址： <https://www.ys-traffic.com>

